



SPA Installation and Directions of Use

EMPV-SPA3528



Content

Warnings.....	1
I. USA Balboa Control System Instructions.....	2
CNBP501X Tech Sheet.....	2
Basic Functions Setup.....	3
Hardware Setup.....	4
II. Description on Using Parts.....	14
1. Heater / Thermostat.....	14
2. Air pump.....	14
3. Paper element filters daily maintenance.....	14
4. Change and instruction of the selective fragrance box pieces.....	15
III. Description on Installation.....	15
IV. Care and Maintenance.....	15
V. Instructions on Maintenance.....	16
VI. Troubleshooting.....	16

■Warnings:

Please read the following instructions before operation and installation, which is a safety guaranty to SPA users.

1. The system must be installed by qualified technicians, switch for electricity leakage should be installed at a place convenient to be controlled or operated.
2. Reliable grounding protection for the SPA is a must, if not, we won't take responsibility for the bad grounding!
3. Taking load capacity of the wires into consideration when installed, otherwise, this will impact normal function or even occur safety accidents!
4. To ensure sanitation of bathtub, those who have skin or infectious disease should not use the SPA.
5. All the jets, and fountains cannot be shut down completely while keep water pumps working simultaneously, for this will damage the water pumps.
6. Before filling water into the SPA for the first time, please check and shut all drain valves, and all the jets, water pumps joints must be highly tightened (they might be loosen during transportation).
7. The old, kids and those with heart disease and low/high blood pressure should use the SPA cautiously and under the care of the healthy adults; without doctor's professional instruction, pregnant women cannot use the SPA.
8. Risk: when drinking alcohol, taking drugs or medicine, it will be dangerous when using the SPA.
9. Make sure that water slips out of jets regularly, or the relative components will be damaged.
10. Please check the SPA's water temperature before entering.
11. SPA input water temperature should not be over 40 Celsius degrees so as not to get hurt; 30-40 Celsius degree is the safety scope for human body. When you have been in the SPA for over 10-15 minutes, please try to lower the water temperature.
12. Before using the SPA drugs, please take the physical property into consideration, for example, granular or root-like drugs must be walled within filter bag.
13. After finishing strenuous exercise please do not use the SPA immediately.
14. If feeling uncomfortable while or after using the SPA, please stop it right away and go to see the doctor.
15. Do not move or open the lid of filter casually.
16. Excessive exposure to the sun for a long time will damage the SPA surface, when you are not using the SPA, please cover it up against the sunshine.
17. If you use the SPA daily, please clean the paper element filter once per week.
18. The heat preservation cover is formed of foam, prevent kids from playing on it.
19. When filling in water, water should be 2-3cm over the probe screw.
20. No water or water level doesn't reach the probe screw or over all the jets, do not operate the spa.
21. If the spa not to use, please tighten the screw or locks of the hem door.
22. All the maintenance must be done after electricity has been cut off.
23. After the repair work and maintenance completed, check if all the functions run well.
24. In the very cold areas or seasons, please keep the SPA connected with electricity, filled with enough water in the SPA, so as to protect SPA from being frozen or broken, or you can drain water completely and check to assure no water left inside pipes.
25. All the preservation and maintenance must be done by qualified professionals. For more service, please contact the suppliers or sales agents.
26. The product must be permanently connected to the fixed wiring.
27. Parts incorporating electrical components must be located or fixed so that they cannot fall into the SPA..
28. The product should be supplied through a residual current device (RCD), having a rated residual operated current not exceeding 30mA.
29. If your SPA is placed in direct sunlight , as possible as you can, please avoid to place it on the glass floor or near the location of the glass wall , speculate reflection effects can lead too high temperature on partial skirt which will cause skirt deformation.

30. The bearing of the water pumps may get stuck after this SPA hasn't been used for a long time, so the water pumps may not working when pressing the water-pump buttons on control panel. If the water pump not working because of water bearing get stuck, then you can notice that no water current through jets or no suction- force in the skimmer. Please shut down the power ,open the hem doors, find out the water pumps, rotate the blade inside water pumps, turn on the power again, activate the water pumps by pressing the water-pump buttons several times.

31. Sometimes, the water pumps may work or rotate slowly at the beginning and back to normal after working 2-3 seconds. If the water pumps still rotate slowly after 2-3 seconds, please press the water-pump buttons on panel to re-activate the pumps.

32. When you notice the hum of the water pumps while pumps not working (no water current through jets) and overheating water pump surface, please shut down power immediately. It results from air kept inside of water pumps or pipes be block. Please check the water pumps and pipes, fix the problem , and turn on the power again.

33. During installation of the SPA, please keep the whole construction area clean and clear .No mud or metal be left beneath the SPA tub body or near the water pumps. Keep sufficient space for dissipating heat of the working water pumps.

I. USA BALBOA System Instructions

CNBP501X Tech Sheet

Part Number: 56849-02 5.5kW 800 Incoloy
56850-02 4.0kW 800 Incoloy

Custom Box Overlay
Box Overlay Part Number N/A

UL System Model 5.5kW: BP501-CNBP501X-BU
UL System Model 4.0kW: BP501-CNBP501X-BS
Software Version ID: M100_201 V36.0
Software Version: 36.0
File Name: BP501_36.0_CNBP501X_3X15A.hex
Configuration Signature: 890194AA

Eng. Project Number: 4817

Control Panels (See later pages for more information):

spaTouch™2	Any version (version 2.0 or later required for bba™2 fully integrated functionality)
Icon spaTouch™	Any version (version 3.36 or later required for bba™2 fully integrated functionality)
Menued spaTouch™	Any version* (version 2.8 or later required for bba™2 integrated functionality)
TP800	Version 3.1* and later (Version 3.13 or later required for bba™; version 4.11 or later required for bba™2 integrated functionality)
TP600	Version 2.7* and later
TP400T US	Version 2.7* and later (TP400T CE may be used)
TP400W US	Version 2.7* and later (TP400W CE may be used)

* TP600/TP400T/TP400W version 2.14 or later required for new reminders to display correctly.
TP800 version 4.2 or later (or Menued spaTouch™ version 2.2 or later) required for new reminders to display correctly.



Manufactured under one or more of these patents. U.S. Patents: 5332944, 5361215, 5550753, 5559720, 5,883,459, 6253227, 6282370, 6590188, 6976052, 6965815, 7030343, 7,417,834 b2, Canadian Patent: 2342614, Australian patent: 2373248 other patents both foreign and domestic applied for and pending. © Copyright 2014 Balboa Water Group.

Template 56377 10-05-12

56849-02_56850-02_97_A 11-22-16

BALBOA
water group

System Revision History

Part #	EPN	Date	Originator	Changes Made
56582 56583 56584	4195	01-15-14	BWG	BP501G3 initial draft. Adds GFCI Trip (but not GFCI Automatic Test). Updated to latest software version, adding topside-intergrated bba™ support.
ZT000148	4467	02-18-15	Customer	Spin off custom version of BP501G3 without 2-Speed Pump 2, and adding simplified menus version of eash Setup, and with new default Setup.
56746	4467	04-01-15	Customer	Add two new reminders. Release to production.
56746 56799	4467	10-30-15	Customer	Add 4.0kW version.
"	4752	08-25-16	Customer	Change NanTong NBP501X to Canadian Spas CNBP501X, adding Setups for 2 2-speed pumps.
"	4752	09-05-16	Customer	Approved for release, but then retracted, but released anyway due to miscommunication.
56849-01 56850-01	4752	09-28-16	Customer	Reconfigure for 3x15A pumps, and change default Setup to Setup 12.
56849-02 56850-02	4817	11-22-16	BWG	Updated to latest software version, adding topside-intergrated bba™ 2 support. Released to production.

bba™ & bba™2 (Balboa Bluetooth Amp) connection is documented seperately.

bba™ is only integrated into graphic display panels (TP800, TP900 and spaTouch™). With TP600 the Aux button operation of bba™ must be used.

bba™ 2 is only integrated into graphic display panels (TP800, TP900 and spaTouch™). bba™ 2 does not support Aux button operation.

Manufactured under one or more of these patents. U.S. Patents: 5332944, 5361215, 5550753, 5559720, 5,883,459, 6253227, 6282370, 6590188, 6976052, 6965815, 7030343, 7,417,834 b2, Canadian Patent: 2342614, Australian patent: 2373248 other patents both foreign and domestic applied for and pending. © Copyright 2014 Balboa Water Group.

Template 56377 10-05-12

56849-02_56850-02_97_A 11-22-16

Basic Functions Setup 1 - 12

Power Requirements:

240VAC, 50/60Hz*, 48A, Class A GFCI-protected service (Circuit Breaker = 60A max.),
4 wires [hot, hot, neutral, ground]

120/240VAC, 50/60Hz*, 16/40A, Class A GFCI-protected service (Circuit Breaker = 20 /50A max.) - Setups 5 & 10 ONLY,
3 or 4 wires [hot, hot (optional), neutral, ground].

*BP systems automatically detect 50Hz vs 60Hz.

System Ouputs:

Pump 1	240VAC*	2-Speed	15A max	15-minute timer (30-minute timer for low speed)
		This is the heater pump Must deliver 20 GPM through heater		
Pump 2	240VAC	1-Speed	15A max	15-minute timer
		2-Speed in Setups 11 & 12 Unused in Setups 3, 5, 8 & 10		
Pump 3	240VAC	1-Speed	15A max	15-minute timer
		Used in Setups 1 & 6 only		
Blower	240VAC	1-Speed	4A max	15-minute timer
		Used in Setups 2, 3, 7 & 8		
Ozone	240VAC*		.5A max	Slaved to Pump 1 low
Spa Light	10VAC	On/Off	1A max	240-minute timer.
A/V (Stereo)	120VAC	Hot	4A max	Always on
Heater	5.5kW @ 240VAC max			

HiPot Testing Note:
Disconnect slip terminal with green wires from J52 prior to performing HiPot test. Failure to disconnect may cause a false failure of the test. Reconnect terminal to J52 after successful completion of HiPot test.

*Pump 1 and Ozone must be the same voltage.

With 120VAC power input (for Setups 5 & 10 only), Pump 1 and Ozone must be set to 120VAC by moving wires attached to J50 and J51 to area 1 (Neutral).

Manufactured under one or more of these patents. U.S. Patents: 5332944, 5361215, 5550753, 5559720, 5,883,459, 6253227, 6282370, 6590188, 6976052, 6965815, 7030343, 7,417,834 b2, Canadian Patent: 2342614, Australian patent: 2373248 other patents both foreign and domestic applied for and pending. © Copyright 2014 Balboa Water Group.

Template 56377 10-05-12

56849-02_56850-02_97_A 11-22-16

Hardware Setup

Wiring Diagram

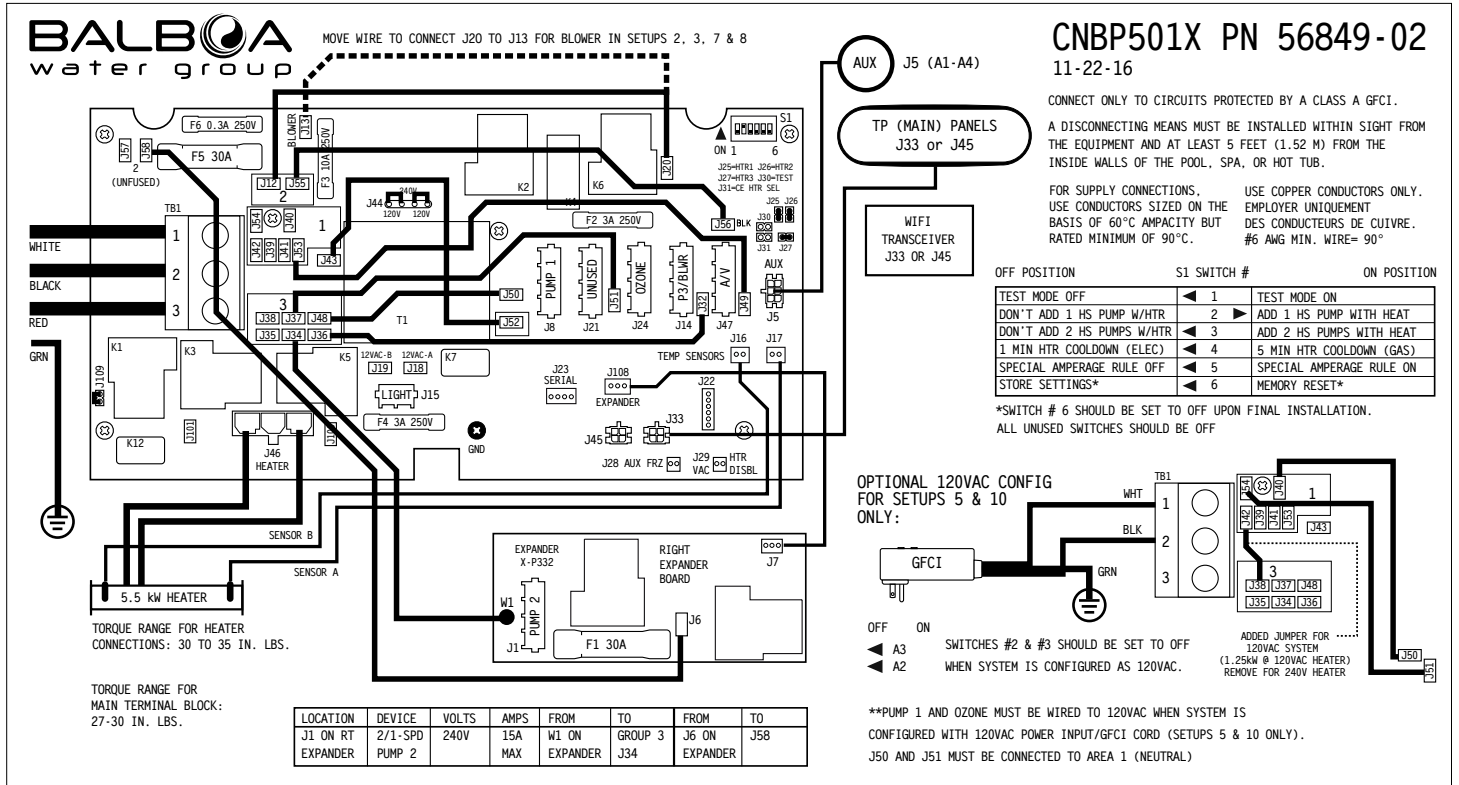

Manufactured under one or more of these patents. U.S. Patents: 5332944, 5361215, 5550753, 5559720, 5,883,459, 6253227, 6282370, 6590188, 6976052, 6965815, 7030343, 7,417,834 b2, Canadian Patent: 2342614, Australian patent: 2373248 other patents both foreign and domestic applied for and pending. © Copyright 2014 Balboa Water Group.

Template 56377 10-05-12

56849-02_56850-02_97_A 11-22-16

Setup Reference Table

Setup #	Circ Pump	Pump 1	Pump 2	Pump 3	Blower	Temp Scale	Menu Style
1	None	2-Speed	1-Speed	1-Speed	None	°F	Standard
2	None	2-Speed	1-Speed	None	1-Speed	°F	Standard
3	None	2-Speed	None	None	1-Speed	°F	Standard
4	None	2-Speed	1-Speed	None	None	°F	Standard
5	None	2-Speed	None	None	None	°F	Standard
6	None	2-Speed	1-Speed	1-Speed	None	°F	Simple
7	None	2-Speed	1-Speed	None	1-Speed	°F	Simple
8	None	2-Speed	None	None	1-Speed	°F	Simple
9	None	2-Speed	1-Speed	None	None	°F	Simple
10	None	2-Speed	None	None	None	°F	Simple
11	None	2-Speed	2-Speed	None	None	°F	Standard
12	None	2-Speed	2-Speed	None	None	°F	Simple

System (and any replacement board) is shipped in Setup 12

Note regarding 3-pump Setups 1 & 6 and DIP switch A5: If not using more than 2A (@120V) AV, and if running on a 48A service (60A breaker), switch A5 can be left OFF, allowing all 3 pumps to run on high speed simultaneously. However, in 40A or 32A service (or if going beyond 2A AV on a 48A service), switch A5 needs to be turned ON (which only allows any 2 of the 3 high-speed pumps to operate at any one time).

As shown on additional wiring diagram section:

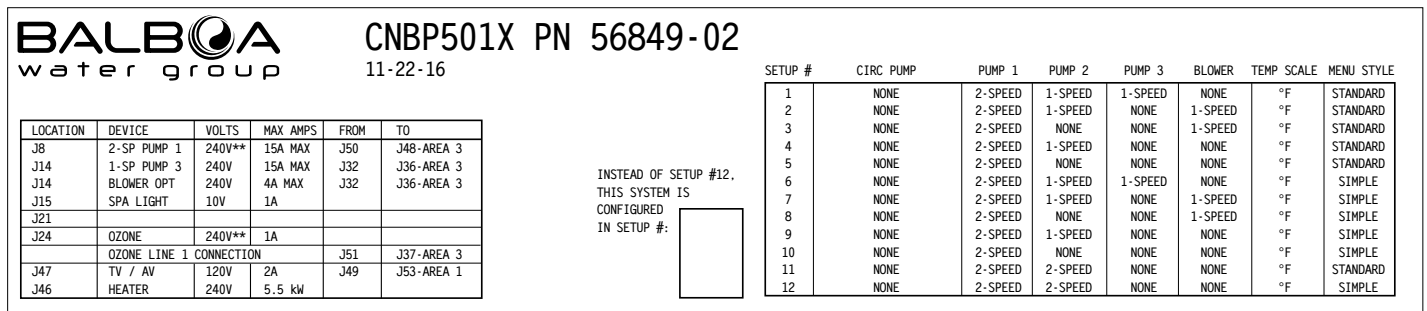

Manufactured under one or more of these patents. U.S. Patents: 5332944, 5361215, 5550753, 5559720, 5,883,459, 6253227, 6282370, 6590188, 6976052, 6965815, 7030343, 7,417,834 b2, Canadian Patent: 2342614, Australian patent: 2373248 other patents both foreign and domestic applied for and pending. © Copyright 2014 Balboa Water Group.

Template 56377 10-05-12

56849-02_56850-02_97_A 11-22-16

Changing Software Setups with TP800 / TP900 / spaTouch™ Menueed Panel

Test Menu Access (S1, Switch 1 ON) Service Technician ONLY.

DANGER! HIGH VOLTAGE WILL BE ACCESSIBLE! SERVICE TECHNICIAN ONLY!

While the system is running, move DIP Switch 1 (on S1 on the Main circuit board) to ON. The system will enter Test Mode. Moving DIP Switch 1 to OFF will exit Test Mode.



Software Setups

Under the TEST Menu, the Setup screen will allow changing the Setup from 1 to any number established by the Manufacturer. Changing the Setup may require wiring changes as well.

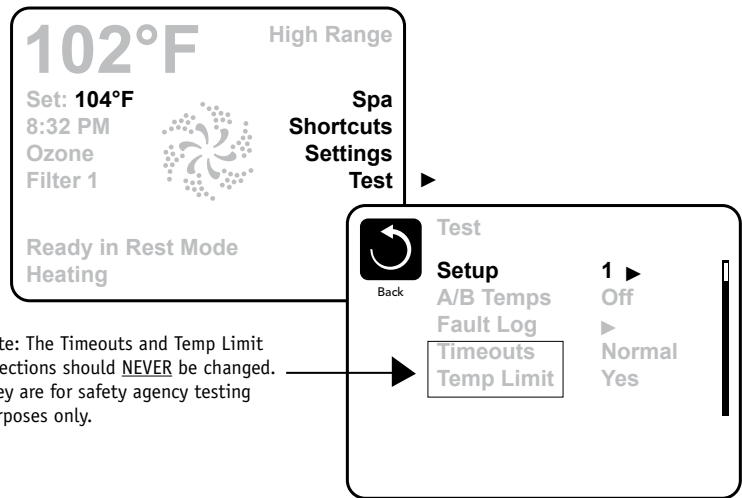

Note: The Timeouts and Temp Limit selections should **NEVER** be changed. They are for safety agency testing purposes only.

Manufactured under one or more of these patents. U.S. Patents: 5332944, 5361215, 5550753, 5559720, 5,883,459, 6253227, 6282370, 6590188, 6976052, 6965815, 7030343, 7,417,834 b2, Canadian Patent: 2342614, Australian patent: 2373248 other patents both foreign and domestic applied for and pending. © Copyright 2014 Balboa Water Group.

Template 56377 10-05-12

56849-02_56850-02_97_A 11-22-16

Changing Software Setups with TP600 / TP400

Test Menu Access (S1, Switch 1 ON) Service Technician ONLY.

DANGER! HIGH VOLTAGE WILL BE ACCESSIBLE! SERVICE TECHNICIAN ONLY!

While the system is running, move DIP Switch 1 (on S1 on the Main circuit board) to ON. The system will enter Test Mode. Moving DIP Switch 1 to OFF will exit Test Mode.

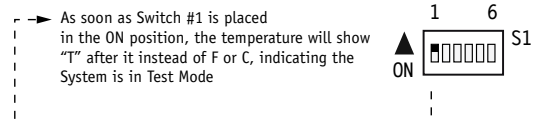

Software Setups

Under the TEST Menu, the Setup screen will allow changing the Setup from 1 to any number established by the Manufacturer. Changing the Setup may require wiring changes as well.

You will have 1 minute to complete the setup change after you manually exit Priming Mode. (Once familiar with the process, the Setup change should take less than 15 seconds.)



When the panel displays RUN PMPS PURG AIR, press any Temperature button ONCE to exit Priming Mode. You should see "---T" where the T indicates the system is in Test Mode.

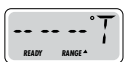

Continued on Next Page.

Manufactured under one or more of these patents. U.S. Patents: 5332944, 5361215, 5550753, 5559720, 5,883,459, 6253227, 6282370, 6590188, 6976052, 6965815, 7030343, 7,417,834 b2, Canadian Patent: 2342614, Australian patent: 2373248 other patents both foreign and domestic applied for and pending. © Copyright 2014 Balboa Water Group.

Template 56377 10-05-12

56849-02_56850-02_97_A 11-22-16

Changing Software Setups with TP600 / TP400 Continued

Again, **You will have 1 minute** to complete the setup change after you manually exit Priming Mode.

Immediately after exiting Priming Mode, press this sequence of buttons: Warm*, Light, Warm, Warm, Warm, Warm. Continue to press Warm until the display shows the Setup Number (S-01, S-02, etc.) you want to switch to. When the correct setup number is showing, press Light once, and the system will reset, using the newly-selected Setup from that point on.

Move DIP Switch 1 to the OFF position to take the spa out of Test Mode. °F or °C will replace °T.

Using a permanent marker, write the Setup number on the Setup label mounted inside the system lid (right). This is very important to any service person in the future who may need to replace a circuit board or system and needs to change the Setup on a replacement part while in the field.

NOTE: Changing the Setup may require wiring changes as well - refer to the wiring diagram or wiring diagram addendum.

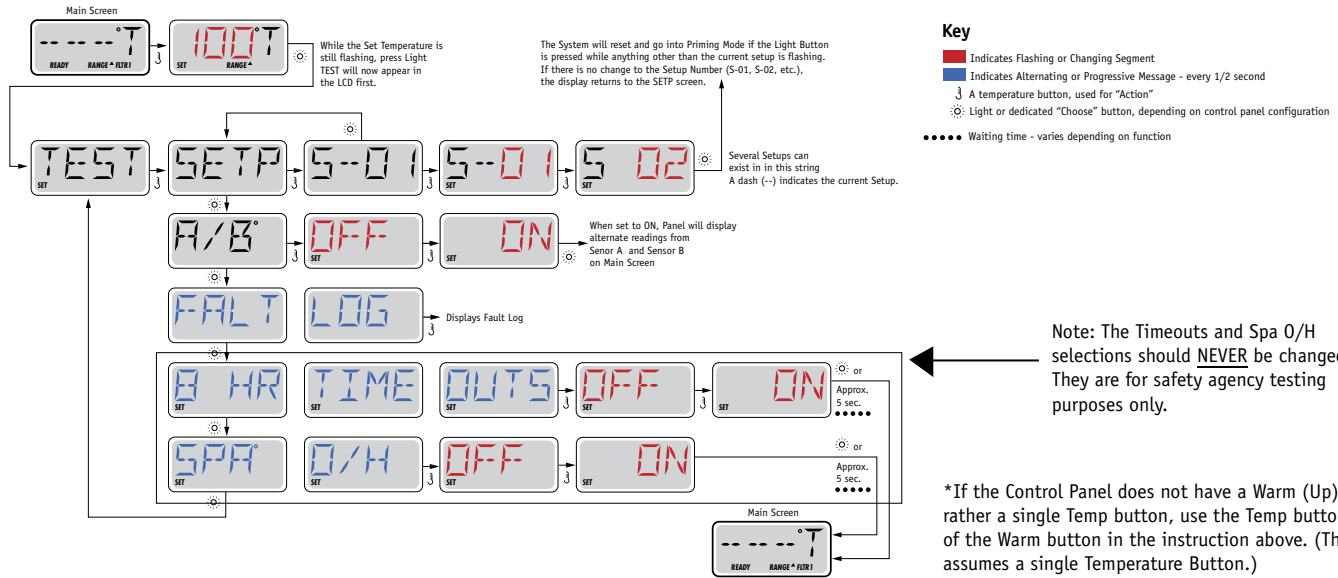
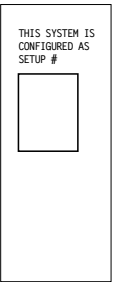

Manufactured under one or more of these patents. U.S. Patents: 5332944, 5361215, 5550753, 5559720, 5,883,459, 6253227, 6282370, 6590188, 6976052, 6965815, 7030343, 7,417,834 b2, Canadian Patent: 2342614, Australian patent: 2373248 other patents both foreign and domestic applied for and pending. © Copyright 2014 Balboa Water Group.

Template 56377 10-05-12

56849-02_56850-02_97_A 11-22-16

Equipment Expansion

Expansion Features

Control Connection

Relay 1/2 (J108)

Default

1-Speed Pump 2
2-Speed Pump 2 in Setups 11 & 12

Fuse

30A

Manufactured under one or more of these patents. U.S. Patents: 5332944, 5361215, 5550753, 5559720, 5,883,459, 6253227, 6282370, 6590188, 6976052, 6965815, 7030343, 7,417,834 b2, Canadian Patent: 2342614, Australian patent: 2373248 other patents both foreign and domestic applied for and pending. © Copyright 2014 Balboa Water Group.

Template 56377 10-05-12

56849-02_56850-02_97_A 11-22-16

DIP Switch Functions

Fixed-function DIP Switches

- A1 Test Mode (normally Off).
- A2 In "ON" position, add one high-speed pump (or blower) with Heater.
- A3 In "ON" position, add two high-speed pumps (or 1 HS Pump and Blower) with Heater.
- A5 In "ON" position, enables Special Amperage Rule B. See Special Features section under Configuration Options for functionality with your system.
In "OFF" position, enables Special Amperage Rule A.
- A6 Persistent memory reset (Used when the spa is powering up to restore factory settings as determined by software configuration).

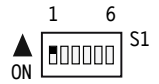

A2 and A3 work in combination to determine the number of high-speed devices and blowers that can run before the heat is disabled. i.e. A2 and A3 in the ON position will allow the heater to operate with up to 3 high-speed pumps (or two HS Pumps and Blower) running at the same time. Heat is disabled when the fourth high-speed pump or blower is turned on.

Note: A2/A3 all off = No heat with any high-speed pump or blower.

Assignable DIP Switches

- A4 In "ON" position, enables a 5-minute cooldown for some gas heaters (Cooling Time B).
In "OFF" position, enables a 1-minute cooldown for electric heaters (Cooling Time A).







Undesignated switches are not assigned a function.

Manufactured under one or more of these patents. U.S. Patents: 5332944, 5361215, 5550753, 5559720, 5,883,459, 6253227, 6282370, 6590188, 6976052, 6965815, 7030343, 7,417,834 b2, Canadian Patent: 2342614, Australian patent: 2373248 other patents both foreign and domestic applied for and pending. © Copyright 2014 Balboa Water Group.

Template 56377 10-05-12

56849-02_56850-02_97_A 11-22-16

Jumper Definitions

J109	GFCI Test/Trip Enable/Disable Note: This feature must be enabled in software as well.	J109 
J30	Do Not Use	
J31	Non Applicable on UL models (Used on CE models only)	J31 
J29	Heater Disable Switch Connection. If J29 is shorted by any means, the heater will not run until J29 is no longer shorted. If J29 is shorted during power-up "J29" will appear on the panel. The message can be dismissed with a button press, and is the only control panel notification of J29 being shorted. No message is displayed if J29 is shorted after power-up, but the heater will not run until J29 is no longer shorted. J29 expects a switch closure (not a voltage) as the command signal. In some areas, a local power company may offer discounts based on voluntary "power shedding" devices that may be installed in conjunction with the spa.	J29 
J25, J26, J27	Heater Type Settings. Note: Factory Configured do not change.	J25  J26  J27 
J44	Jumper on center two pins (230V) when no neutral wire is used (240V-dedicated). Two Jumpers installed; one on left 2 pins and one on right 2 pins (115V) when neutral wire is used.	J44 

Warning!

Setting DIP switches or jumpers incorrectly may cause abnormal system behavior and/or damage to system components.
Refer to Switchbank illustration on Wiring Configuration page for correct settings for this system.
Contact Balboa if you require additional configuration pages added to this tech sheet.

Manufactured under one or more of these patents. U.S. Patents: 5332944, 5361215, 5550753, 5559720, 5,883,459, 6253227, 6282370, 6590188, 6976052, 6965815, 7030343, 7,417,834 b2, Canadian Patent: 2342614, Australian patent: 2373248 other patents both foreign and domestic applied for and pending. © Copyright 2014 Balboa Water Group.

Template 56377 10-05-12

56849-02_56850-02_97_A 11-22-16

Replacement Parts

PCBA:

Main PCBA:	56851-02
Expander PCBA:	551537

HEATER(s):

Plug + Click Heater Kit:	58306 5.5kW 800Inc 58303 4.0kW 800Inc
Temp Sensor Kit:	53605

CABLES:

21302 Jumper 120V Heater

FUSES:

Part Number	Amperage	Location
30136	30A	F5, F1 (Expander)
20600	3A	F2, F4
21581	3/10A	F6
30122	10A	F3

Manufactured under one or more of these patents. U.S. Patents: 5332944, 5361215, 5550753, 5559720, 5,883,459, 6253227, 6282370, 6590188, 6976052, 6965815, 7030343, 7,417,834 b2, Canadian Patent: 2342614, Australian patent: 2373248 other patents both foreign and domestic applied for and pending. © Copyright 2014 Balboa Water Group.

Template 56377 10-05-12

56849-02_56850-02_97_A 11-22-16



BP501 Configuration Options

General Features

Feature	Default	
Pump 1 in Filter Cycle (Circ Only)	No	
Pump 1 Low Timer	<i>30 Minutes</i>	Applies in non-circ Setups (configurations) only
General Pump Timer	15 Minutes	
Blower Timer	15 Minutes	
Mister Timer	15 Minutes	
Light Timer	240 Minutes	
Circ (when enabled)	Programmable + Polling	
Cleanup Cycle	<i>30 Minutes</i>	
Cleanup as Preference setting	<i>Yes</i>	
Ozone	With Heater Pump*	
Ozone Suppression	OFF	
Pump Purge	60 Seconds	
Blower Purge	30 Seconds	
Mister Purge	5 Seconds	
Purge Type	Serial - Pumps at lowest speed	

* The heater Pump can be either a Circ Pump or Pump 1 Low.

Manufactured under one or more of these patents. U.S. Patents: 5332944, 5361215, 5550753, 5559720, 5,883,459, 6253227, 6282370, 6590188, 6976052, 6965815, 7030343, 7,417,834 b2, Canadian Patent: 2342614, Australian patent: 2373248 other patents both foreign and domestic applied for and pending. © Copyright 2014 Balboa Water Group.

Template 56377 10-05-12

56849-02_56850-02_97_A 11-22-16

BP501 Configuration Options

Temperature Features

Feature	Default
Temperature Display	°F

All temperatures must be specified in °F. The system converts °F to °C dynamically. If Celsius is required for default settings, choose a desired °C value that (after rounding) corresponds to a Fahrenheit value.

°C	4	5	6	7	8	9	10	11	12	13	14	15	16	17	18	19	20	21	22
°F	39	41	43	45	46	48	50	52	54	55	57	59	61	63	64	66	68	70	72
°C	23	24	25	26	27	28	29	30	31	32	33	34	35	36	37	38	39	40	
°F	73	75	77	79	81	82	84	86	88	90	91	93	95	97	99	100	102	104	

Hi-Range Min. Set Temp	80°F
Hi-Range Max. Set Temp	104°F
Hi-Range Default Temp*	100°F
Lo-Range Min. Set Temp	50°F
Lo-Range Max. Set Temp	99°F
Lo-Range Default Temp*	70°F
Freeze Threshold	44°F
Freeze Type	Rotating - Pumps at Lowest Speed
Temp Lock Type	Temp + Settings

*May be changed by end-user (if enabled)

Manufactured under one or more of these patents. U.S. Patents: 5332944, 5361215, 5550753, 5559720, 5,883,459, 6253227, 6282370, 6590188, 6976052, 6965815, 7030343, 7,417,834 b2, Canadian Patent: 2342614, Australian patent: 2373248 other patents both foreign and domestic applied for and pending. © Copyright 2014 Balboa Water Group.

Template 56377 10-05-12

56849-02_56850-02_97_A 11-22-16

BP501 Configuration Options

Time Features

Feature	Default
Time Format*	12 Hour
Filter 1 Start Hour*	20:00 (8:00 PM)
Filter 1 Duration*	2 Hours
Filter Cycle 2 Default*	ON
Filter 2 Start Hour*	08:00 (8:00 AM)
Filter 2 Duration*	2 Hours
Light Cycle	Disabled
Light Cycle Default*	OFF
Light Cycle Start Hour*	21:00 (9:00 PM)
Light Cycle Duration*	15 Minutes
Cooling Time A	1 Minute
Cooling Time B	5 Minutes

*May be changed by end-user (if enabled)

Manufactured under one or more of these patents. U.S. Patents: 5332944, 5361215, 5550753, 5559720, 5,883,459, 6253227, 6282370, 6590188, 6976052, 6965815, 7030343, 7,417,834 b2, Canadian Patent: 2342614, Australian patent: 2373248 other patents both foreign and domestic applied for and pending. © Copyright 2014 Balboa Water Group.

Template 56377 10-05-12

56849-02_56850-02_97_A 11-22-16

BP501 Configuration Options

Reminder Features

Feature	Default
Reminders Shown*	Yes
Check pH	7 Days
Check Sanitizer	7 Days
Clean Filter	7 Days
Test GFCI	60 Days
Drain Water	90 Days
Change Cartridge	OFF
Clean Cover	90 Days
Treat Wood	OFF
Change Filter	120 Days
Check Ozone (E047**)	365 Days
Service Check-up (E048**)	240 Days

** On TP panels that have not been updated to display these new reminders, they will display as these numeric codes.

*May be changed by end-user (if enabled)

Manufactured under one or more of these patents. U.S. Patents: 5332944, 5361215, 5550753, 5559720, 5,883,459, 6253227, 6282370, 6590188, 6976052, 6965815, 7030343, 7,417,834 b2, Canadian Patent: 2342614, Australian patent: 2373248 other patents both foreign and domestic applied for and pending. © Copyright 2014 Balboa Water Group.

Template 56377 10-05-12

56849-02_56850-02_97_A 11-22-16

BP501 Configuration Options

Special Features

Feature	Default
Special Amperage Rule A	No Limitation
Special Amperage Rule B	2 High-Speed Pumps Maximum

Drain Mode	Disabled
Demo Mode	Disabled
GFCI Trip	Enabled
Automatic GFCI Test	Disabled

Ozone Slaved to Heater Pump *Yes*

Dual Voltage Heater	Always Input Voltage
Safety Suction	Disabled

Menu Style *Standard in Setups 1 - 5 & 11
Simple in Setups 6 - 10 & 12*

Manufactured under one or more of these patents. U.S. Patents: 5332944, 5361215, 5550753, 5559720, 5,883,459, 6253227, 6282370, 6590188, 6976052, 6965815, 7030343, 7,417,834 b2, Canadian Patent: 2342614, Australian patent: 2373248 other patents both foreign and domestic applied for and pending. © Copyright 2014 Balboa Water Group.

Template 56377 10-05-12

56849-02_56850-02_97_A 11-22-16

TP800 Panel Configuration

Button Layout Table

Feature #	Setup 1	Setup 2	Setup 3	Setups 4 & 11	Setup 5
A1	N/A	N/A	N/A	N/A	N/A
A2	Jets 1	Jets 1	Jets 1	Jets 1	Jets 1
A3	Jets 2	Jets 2	Blower	Jets 2	Light 1
A4	Jets 3	Blower	Light 1	Light 1	Invert
A5	Light 1	Light 1	Invert	Invert	Undefined
A6	Invert	Invert	Undefined	Undefined	Undefined
A7	Undefined	Undefined	Undefined	Undefined	Undefined
A8	Undefined	Undefined	Undefined	Undefined	Undefined
A9	Undefined	Undefined	Undefined	Undefined	Undefined
A10	Undefined	Undefined	Undefined	Undefined	Undefined
A11	N/A	N/A	N/A	N/A	N/A
A12	N/A	N/A	N/A	N/A	N/A
A13	Undefined	Undefined	Undefined	Undefined	Undefined
A14	Undefined	Undefined	Undefined	Undefined	Undefined
A15	Undefined	Undefined	Undefined	Undefined	Undefined
A16	Undefined	Undefined	Undefined	Undefined	Undefined
B1	Jets 1	Jets 1	Jets 1	Jets 1	Jets 1
B2	Jets 2	Jets 2	Blower	Jets 2	Undefined
B3	Jets 3	Blower	Undefined	Undefined	Undefined
B4	Light 1	Light 1	Light 1	Light 1	Light 1

Manufactured under one or more of these patents. U.S. Patents: 5332944, 5361215, 5550753, 5559720, 5,883,459, 6253227, 6282370, 6590188, 6976052, 6965815, 7030343, 7,417,834 b2, Canadian Patent: 2342614, Australian patent: 2373248 other patents both foreign and domestic applied for and pending. © Copyright 2014 Balboa Water Group.

Template 56377 10-05-12

56849-02_56850-02_97_A 11-22-16

TP800 Panel Configuration

Spa Screen

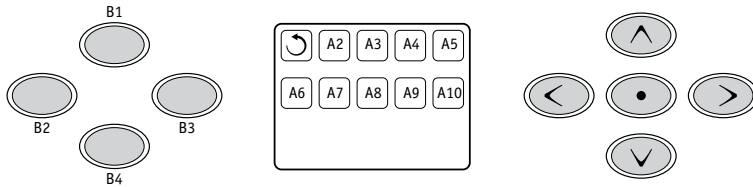

Shortcuts Screen

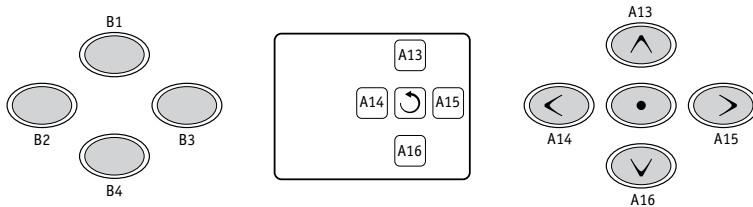

Note: Buttons 11 and 12 are not used in this configuration.

Button 1 is fixed.

Panel Part Number 50204-XX

Overlay Part Number N/A

Manufactured under one or more of these patents. U.S. Patents: 5332944, 5361215, 5550753, 5559720, 5,883,459, 6253227, 6282370, 6590188, 6976052, 6965815, 7030343, 7,417,834 b2, Canadian Patent: 2342614, Australian patent: 2373248 other patents both foreign and domestic applied for and pending. © Copyright 2014 Balboa Water Group.

Template 56377 10-05-12

56849-02_56850-02_97_A 11-22-16

TP600 Panel Configuration

Button Layout Table

Button #	Setups 1 & 6	Setups 2 & 7	Setups 3 & 8	Setups 4, 9, 11 & 12	Setups 5 & 10
1	Jets 1	Jets 1	Jets 1	Jets 1	Jets 1
2	Jets 2	Jets 2	Blower	Jets 2	Undefined
3	Jets 3	Blower	Invert	Invert	Invert
4	Up	Up	Up	Up	Up
5	Light 1	Light 1	Light 1	Light 1	Light 1
6	Down	Down	Down	Down	Down
LED 1	Jets 1	Jets 1	Jets 1	Jets 1	Jets 1
LED 2	Jets 2	Jets 2	Blower	Jets 2	Undefined
LED 3	Light 1	Light 1	Light 1	Light 1	Light 1
LED 4	Heat On	Heat On	Heat On	Heat On	Heat On



TP600

55676-XX

No Overlay

Manufactured under one or more of these patents. U.S. Patents: 5332944, 5361215, 5550753, 5559720, 5,883,459, 6253227, 6282370, 6590188, 6976052, 6965815, 7030343, 7,417,834 b2, Canadian Patent: 2342614, Australian patent: 2373248 other patents both foreign and domestic applied for and pending. © Copyright 2014 Balboa Water Group.

Template 56377 10-05-12

56849-02_56850-02_97_A 11-22-16

TP400 Panel Configuration

Button Layout Table for TP400T

Button #	Setups 3 & 8	Setups 4, 9, 11 & 12	Setups 5 & 10
1	Temperature	Temperature	Temperature
2	Jets 1	Jets 1	Jets 1
3	Light 1	Light 1	Light 1
4	Blower	Jets 2	Undefined
LED 1	Heater ON	Heater ON	Heater ON
LED 2	Jets 1 ON	Jets 1 ON	Jets 1 ON
LED 3	Light ON	Light ON	Light ON
LED 4	Blower ON	Jets 2 ON	Undefined

TP400T is not supported in Setups 1, 2, 6 & 7 (that have either Pump 3 or both Pump 2 and Blower).

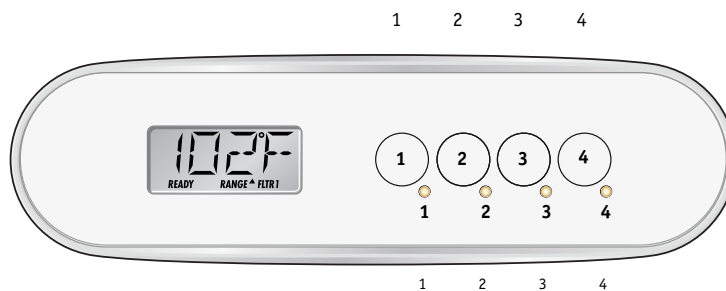

TP400T

50260-XX

Includes overlay PN 12511.

Button Layout Table for TP400W

Button #	All Setups
1	Up
2	Down
3	Light 1
4	Jets 1
LED 1	Heater ON
LED 2	Undefined
LED 3	Light ON
LED 4	Jets 1 ON

Use the TP400W for setups that only have one pump (No Blower or Pump 2 or Pump 3).

TP400W

50259-01 or later

Includes overlay PN 12510.

Manufactured under one or more of these patents. U.S. Patents: 5332944, 5361215, 5550753, 5559720, 5,883,459, 6253227, 6282370, 6590188, 6976052, 6965815, 7030343, 7,417,834 b2, Canadian Patent: 2342614, Australian patent: 2373248 other patents both foreign and domestic applied for and pending. © Copyright 2014 Balboa Water Group.

Template 56377 10-05-12

56849-02_56850-02_97_A 11-22-16

BP501 Configuration Options

Auxilliary Panel Features on Bank 1*

Feature	Default
Aux Button A1	Jets 1
Aux Button A2	Jets 2
Aux Button A3	Jets 3 in Setups 1 & 6 Blower in Setups 2, 3, 7 & 8 Undefined in Setups 4, 5, 9 & 10
Aux Button A4	Light

Buttons that are assigned to equipment that is not defined in a Setup will not do anything in that Setup.

*Bank 1 consists of J5 on the Main Circuit Board.

Aux Connection Splitter PN 25257 may be required.

Manufactured under one or more of these patents. U.S. Patents: 5332944, 5361215, 5550753, 5559720, 5,883,459, 6253227, 6282370, 6590188, 6976052, 6965815, 7030343, 7,417,834 b2, Canadian Patent: 2342614, Australian patent: 2373248 other patents both foreign and domestic applied for and pending. © Copyright 2014 Balboa Water Group.

Template 56377 10-05-12

56849-02_56850-02_97_A 11-22-16

BP501 Configuration Options

Auxilliary Panel Features

AX10 Panels on Bank 1*

A1, AX10A1	No O/L	52803
A2, AX10A2	No O/L	52804
A3, AX10A3	No O/L	52805
A4, AX10A4	No O/L	52806

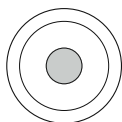

Call Customer Service for additional information about Auxiliary Panels.

*Bank 1 consists of J5 on the Main Circuit Board.

Aux Connection Splitter PN 25257 may be required.

AX20

AX20 A1A2	No O/L	52800
AX20 A1A3	No O/L	52801
AX20 A1A4	No O/L	52802

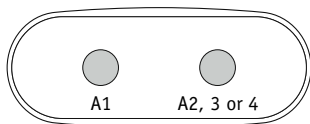

AX20 Auxiliary Panel plugged into Bank 1 will operate A1 + A2, A3 or A4.

AX40

AX40	No O/L	52799
------	--------	-------

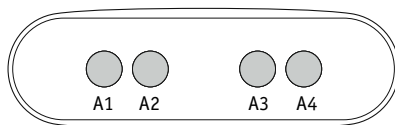

AX40 Auxiliary Panel plugged into Bank 1 will operate A1 + A2, A3 and A4.

Manufactured under one or more of these patents. U.S. Patents: 5332944, 5361215, 5550753, 5559720, 5,883,459, 6253227, 6282370, 6590188, 6976052, 6965815, 7030343, 7,417,834 b2, Canadian Patent: 2342614, Australian patent: 2373248 other patents both foreign and domestic applied for and pending. © Copyright 2014 Balboa Water Group.

Template 56377 10-05-12

56849-02_56850-02_97_A 11-22-16

II. Description on Using Parts

1. Heater/Thermostat

1) Normal starting up time is 4-8 hours

2) SPA Thermostat cannot be heated by man in the air, or there will be danger. If there is something wrong in operation, professional servant is a must to prevent the risk of electricity leakage.

2. Air pump

Normal working time is 15-30 minutes (air pump shall not be working continuously over 120min., because it may overheat the whole part or shorten service life).

Please notice that water level should not be 7cm over the tub water level to prevent air pump being burnt out by water leakage.

3. Paper element filters daily maintenance

Type one:

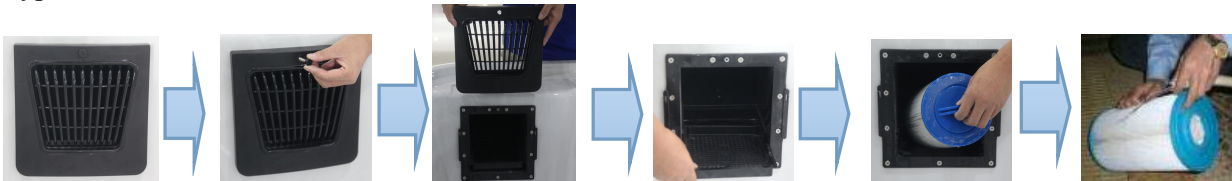

- 1) Remove the outer cover of the skimmer
- 2) Pull out the skimmer screw
- 3) Take out the paper core
- 4) Wash the paper core with water, reset it after cleaning and dry out

Type two:



- 1) Pull apart the crystal package of the paper core
- 2) Pull out the cover of filtration bucket
- 3) Match the paper core inside and screw it tight, then put the cover of filtration bucket back

Type three:

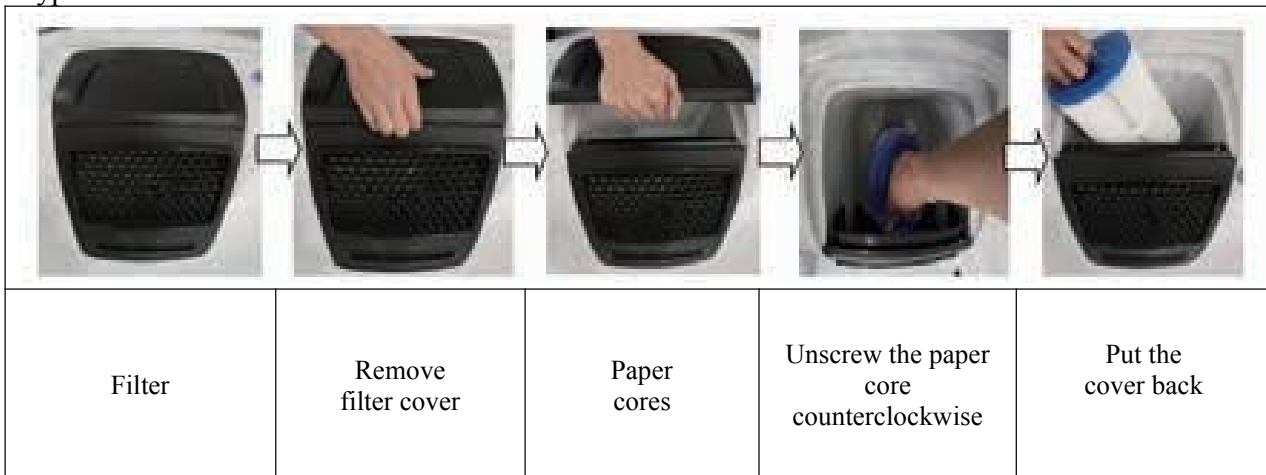

Type four:



- 1) Remove the cover on the filter, and screw the core paper filter out.
- 2) Repeatedly Clean the core paper filter with water.
- 3) Put the core paper filter back to use after dry out.

4) Change the core paper filter half a year once, depends on the high quality of water, lifetime of paper filter can be properly extended.

5) Change a new paper filter, take out a new one and tear out the package of the paper core and put it inside the filtration bucket.

6) Match the paper core correctly inside and screw it down in sequence, then put the cover of filtration bucket on top.

Notice: Different spa model with standard configuration will be equipped with one of these two filtration, please install and clean the paper core in accord with the proper filtration system you purchase.

III. Water pipes connection of SPA

Drain of SPA in hem side



sketch map of connection

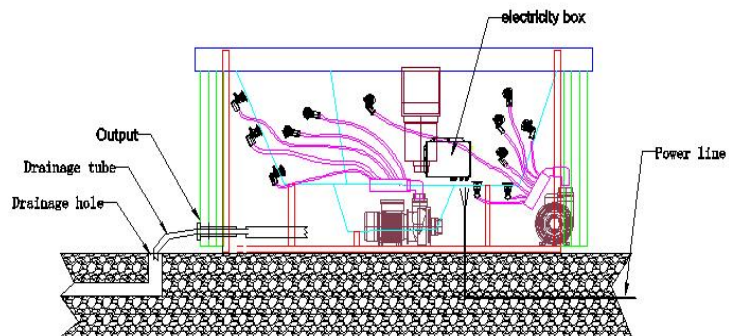

DRAIN INSTRUCTIONS

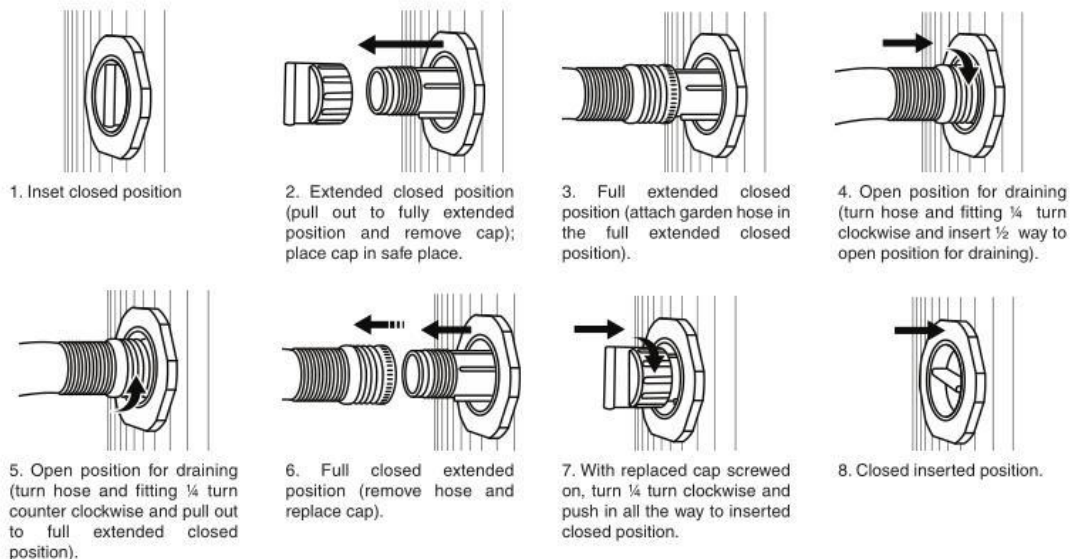

IV. Care and Maintenance

1) Please clean the massage bathtub with neutral detergent and soft fabric. Do not clean it with acetone, solution, ammonia water and organic solvent, otherwise, it may possibly damage the surface of the bathtub. Mildly wipe off the adhesive stains on the bathtub with soft fabric and gasoline.

2) If there's scratches on the bathtub, please grind with 2000# grinding paper with water, and then polish with toothpaste and soft fabric.

3) Please wipe off the water scale on the bathtub with light acid detergent such as citric acid and vinegar.

- 4) Remove the water-return unit and nozzle for cleaning and removing dirt.
- 5) Do not frequently wipe the gold and chrome plated parts (do not contact it with organic solvent).
- 6) Please keep blunt and knife away from the surface, and butt or the things over 60 degree should be away from that too.
- 7) One time to check button of electricity leakage every month.
- 8) Make frequent checks on the electrical wires, buttons, connectors always to see if they are bitten by rats or worms.
- 9) Make frequent checks on the feed pipe and drain pipe always to see if there is some parts broken or hand make sure it is smooth.
- 10) When storing the products, do not put converted and overlapped, make sure they are far away from formic acid and methanal as well as any other organic solvent.
- 11) If they are needed to be carried, do take those actions lightly, in case of high pressure, mechanical impact strength and succession.
- 12) If the bathtub are not to be used for a long time, dry inside the bathtub and make the circumstance dry and ventilated as well as no corrosive gas.

V. Instructions on Maintenance

- 1) Replace the massage water pump: cut off power supply, open the bathtub side plate, drain empty the SPA water, remove the wires and open the water pump, loosen the fixed bolts and take out the water pump, after replacing the pump, install power wire, fix the bolts, put into small amount of water into the bathtub, check if there's leakage at the pump, and then install the side plate of the bathtub.
- 2) Replace the filter water pump: cut off power supply, open the bathtub side plate, turn off the valves on both ends of water pump, remove the wires and open the water pump, loosen the fixed bolts and take out the water pump, after replacing the pump, install power wire, fix the bolts, put into small amount of water into the bathtub, turn on the valve, check if there's leakage at the pump, and then install the side plate of SPA.
- 3) Replace the thermostat: cut off power supply, open the bathtub side plate, turn off the valves on both ends of thermostat, remove the wires, loosen the fixed bolts and take out the thermostat, after replacement, install power wire, fix the bolts, put into small amount of water into the bathtub, turn on the valve, check if there's leakage at the pump, and then install the side plate of the bathtub.
- 4) Replace the filter core: cut off power supply, open the bathtub side plate, turn off the valves, loosen the bolts on top of the filter, take out the filter, remove dirt on bottom of the filter.
- 5) Anti-frozen of filter: In some area, water may be frozen in winter, under this case, please stop using filter, to remove it and clean the core, store it in safe place or move the filter core to interior. Or keep the SPA at standby state.

VI. Troubleshooting

Faults	Reason	Solution
No reaction for panel Key	1. Panel was locked 2. Panel is broken	Unlock the panel Change panel
No power supply	1. There's problem for the power circuit; 2. Protective switch is cut off.	Check the circuit; Check and remove short circuit, Connect the protective switch
Nozzle doesn't spray water	1. There's problem for power supply of water pump; 2. Water pump is not started. 3. Massage water pump is damaged 4. There is air in pipe	Check and connect the power wire Check the massage water pump Replace the massage water pump Purify pipe by taking the loose joint part
Bottom lamp doesn't light on	1. Bulb is broken; 2. Fuse is damaged.	Replace the bulb Replace the fuse
Poor filtering effect	1. Filter water pump is not started; 2. Filter is not cleaned;	Start the filter water pump Clean the filter

	3. Filter water pump is damaged.	Replace the filter water pump
Constant temperature effect is unavailable	1. Thermostat is damaged; 2. Power supply is unavailable. 3. Filter is jammed.	Repair or replace the thermostat Check the power supply Clean or replace the filter paper core
Bathtub is scratched		Grind with 2000# grinding paper with water, and then polish with toothpaste and soft fabric

NOTICE: The usage manual is only for reference, and all data subject to the actual product, any update without notice.



EMPAVA APPLIANCES INC.

15253 DON JULIAN RD CITY OF INDUSTRY, CA 91745

TEL: 888-682-8882

WWW.EMPAVA.COM